

Număr model :
2312-862-84

ESENA

2D1W

Typ:
862

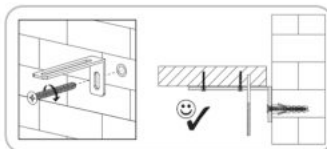
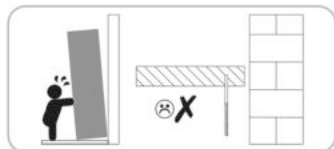
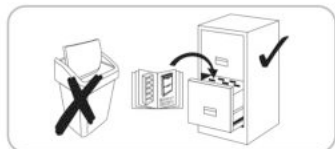
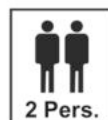
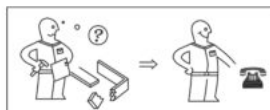
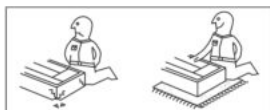
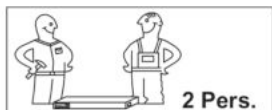

Ø8

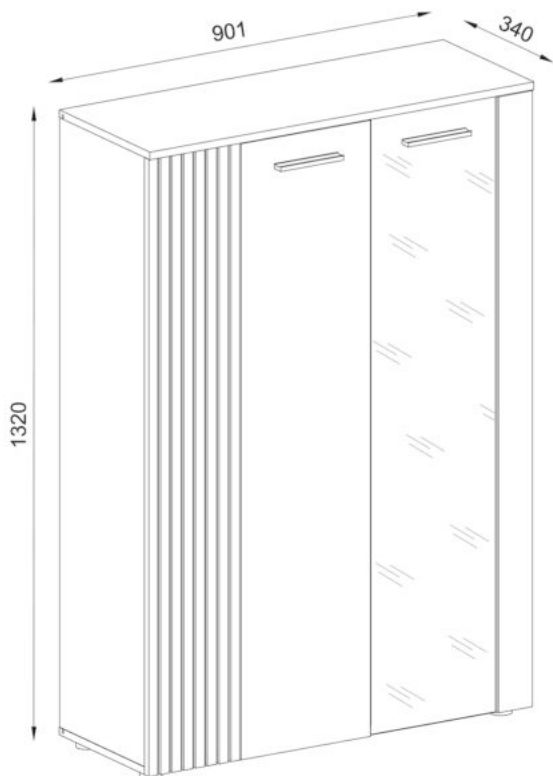

strângere



introducere prin apăsare



măsurare



apăsare



introducere prin bătaie





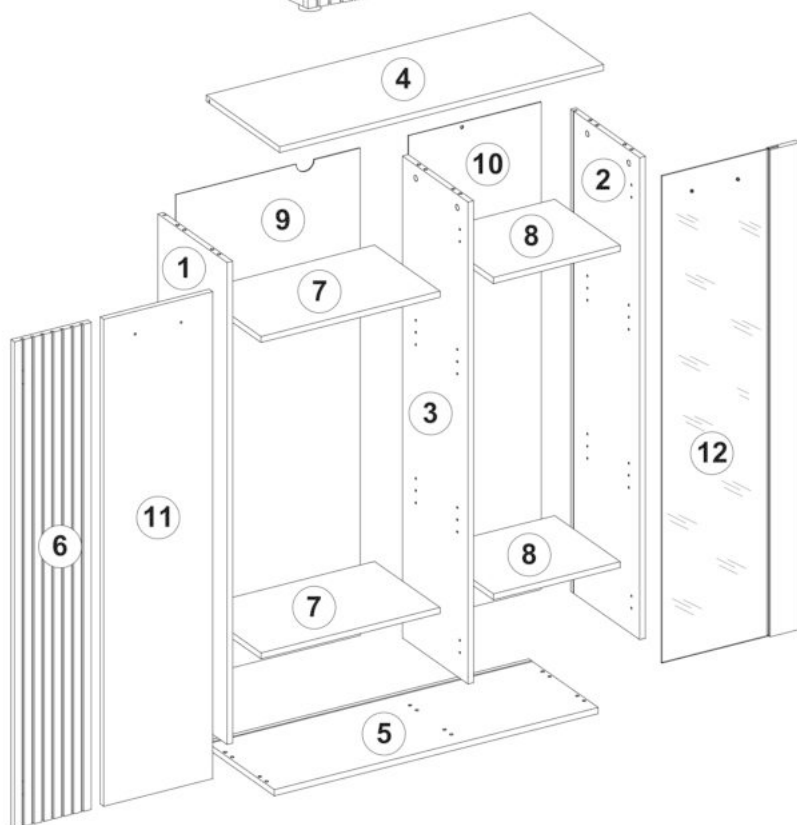



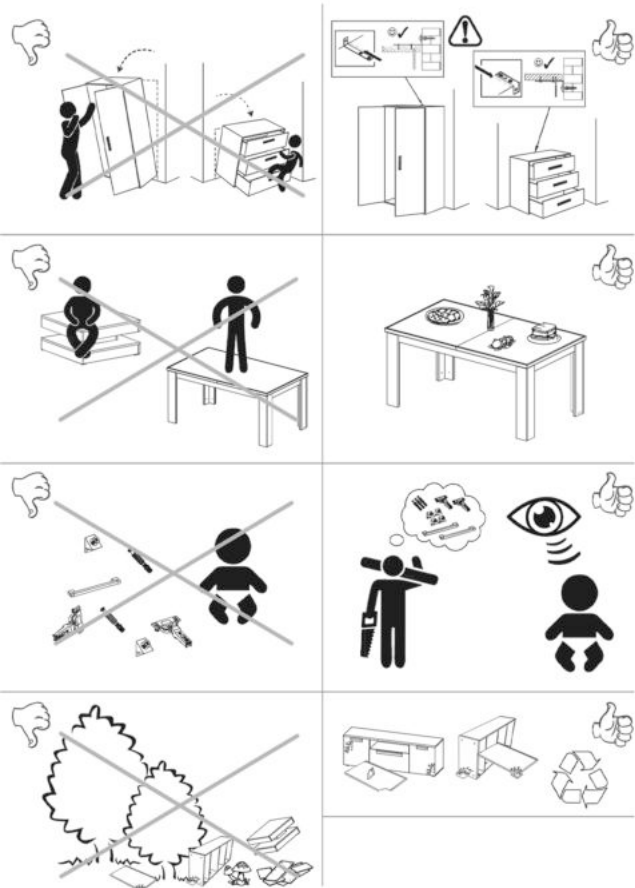















Întoarceți - rotiți



A	B (mm)		C	D
1	1268	320	16 x1	1/2
2	1268	320	16 x1	1/2
3	1268	304	16 x1	1/2
4	901	340	16 x1	1/2
5	901	320	16 x1	2/2
6	1281	214	16 x1	2/2
7	498	295	16 x2	2/2
8	353	295	16 x2	1/2, 2/2
9	1282	512	2,5 x1	2/2
10	1282	369	2,5 x1	2/2
11	1281	303	16 x1	2/2
12	1281	376	16 x1	2/2
B1				1/2



B1 1/2

A1 15x12  x6	C2 44mm  x6	O1 ø18mm  x6
N5 10x6x10  x2	F3 6,3x50  x6	FA1 4mm  x1
B2 8x30  x12	P18 45x25  x5	K6 ø35mm  x4
K7 ø35mm  x2	J65 128/148  x2	R5 ø6mm  x4
DA21 4,2x16  x2	M1 10x10x15  x18	S4 20x10x2mm  x5
D25 4x25  x5	DB2 4x25  x2	D10 3x16  x7
D11 3,5x16  x12	Y36 75x25x15  x1	N1 ø6mm  x16
Y37 8x50  x1	Y35 4,2x65  x1	

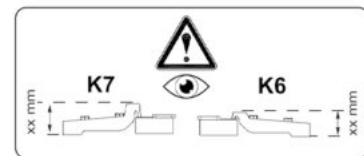

Stimată clientă, stimat client, Îți mulțumim pentru achiziția unei piese de mobilier din programul nostru de interior pentru utilizarea exclusivă în încăperi private. Vă rugăm să verificați integritatea volumului livrării și să citiți cu atenție informațiile importante de mai jos înaintea montajului și să le păstrați pentru utilizarea ulterioară, inclusiv de către terți. Piesele noastre de mobilier trebuie să fie folosite conform destinației. Utilizarea neconformă destinației poate cauza daune materiale sau în anumite circumstanțe vătămări corporale. Piesele de mobilier nu sunt jucării. Producătorul sau comerciantul nu își asumă răspunderea pentru daune, care sunt provocate prin utilizarea neconformă destinației sau prin manipularea greșită.

ATENȚIE: Copiii și persoanele cu handicap psihic trebuie să fie ținute întotdeauna la distanță față de piese de mobilier, obiecte ascuțite, piese mici și materiale de ambalaj, există pericolul de vătămare și/sau asfixiere.

MONTAJ: Pentru montaj, vă rugăm să vă orientați după instrucțiunile noastre de funcționare, de operare, de instalare sau de montaj și să respectați în special avertismentele și indicațiile de siguranță. Dacă instrucțiunile nu au fost respectate, acest fapt poate să provoace leziuni la persoane sau daune la mobilier / pot să devină un risc de siguranță. Dacă aveți dificultăți la asamblare / montaj, vă rugăm să contactați echipa noastră de service. Aceasta vă stă alături cu sfaturi și asistență. Montajul poate fi efectuat numai de către persoane calificate. În cazul modificărilor la produs/piese ale produsului, în cazul schimbării, respectiv al înlocuirii pieselor / materialelor de consum, care nu provin de la producător/comerciant, nu se poate prelua nicio răspundere pentru daune.

Dacă marfa include mijloace de montare pe perete, precum dibluri și șuruburi, acestea sunt destinate exclusiv pentru utilizarea la pereți din materiale masive și unitare. O fixare este numai așa de bună ca legătura dintre mijlocul de fixare și perete. Vă rugăm să verificați atât în cazul pieselor de mobilier de sine stătătoare cât și al celor suspendate, înainte de fixarea lor, perețele dumneavoastră cu privire la adecvarea în acest sens și utilizați numai mijloacele de montare adecvate. Înaintea eventualelor lucrări de găurire, asigurați-vă că nu se află cabluri în zona de găurire. În final, montatorul este responsabil pentru fixarea sigură de perete. Aceasta privește și instalarea articolelor electrice, precum și celelalte accesorii tehnice constructive. Montarea / instalarea articolelor electrice, precum și a altor accesorii relevante constructiv trebuie să fie efectuate numai de personal calificat autorizat. Toate instalațiile electrice, precum și tehnice constructive trebuie să fie executate conform standardelor respective valabile, respectiv normelor de siguranță din țara dumneavoastră. Pentru sursele de lumină vă rugăm să folosiți numai intensitățile admisibile ale corpurilor de iluminat. În cazul nerespectării numărului max. de Watt există pericol de incendiu din cauza supraîncălzirii. Trebuie să se omită acoperirea corpului de iluminat din cauza pericolului de incendiu. O funcționare perfectă a mobilierului este garantată numai în cazul unei amplasări verticale și orizontale. Ușile sunt ajustate în prealabil, însă trebuie eventual aliniate / reglate din nou din cauza condițiilor locale. Vă rugăm să respectați neapărat indicațiile de greutate privind sarcina maximă. Nu este permis să urcați pe mobilă. În cazul utilizării necorespunzătoare, poate să apară răsturnarea pieselor de mobilier. Pentru a preveni acest fapt, piesele de mobilier ar trebui asigurate întotdeauna împotriva răsturnării. În cazul suprasarcinilor/supraîncălziturilor (în special prin copii care se joacă, oameni, materiale sau alte acțiuni necorespunzătoare) există pericolul de rupere și leziune. Toate șuruburile, precum și punctele de îmbinare portante ar trebui strânse din nou după 5 până la 6 săptămâni, pentru a asigura o stabilitate permanentă.

ÎNGRIJIRE:-Indicații de îngrijire a mobilei- Vă rugăm să respectați indicațiile noastre cu privire la îngrijirea corectă a mobilei, astfel încât să vă bucurați cât de mult posibil de produsul nostru.

Pentru curățare, utilizați o lavetă de bumbac curată, uscată și moale. Dacă mobilierul dumneavoastră necesită o curățare temeinică, puteți să umeziți laveta cu puțină apă sau soluție de curățare a mobilei și apoi să uscați elementele curățate. Cel mai bine curățați piesele din metal și sticlă cu soluții de curățare a metalului și a sticlei uzuale din comerț conform instrucțiunilor de îngrijire de pe acestea. Soluțiile de curățare trebuie să poarte o indicație clară că sunt adecvate pentru îngrijirea mobilei. În niciun caz nu folosiți aparate de curățare cu abur, precum și substanțe caustice, abrazive sau alte substanțe al căror efect nu îl cunoașteți.

ATENȚIE: Suprafețele lucioase sunt protejate printr-afolie la livrare. Lăsați-o pe mobilă, până când este montată complet și curățată de praf. Elementele lucioase, de pe care s-a îndepărtat folia de protecție pot fi curățate și folosite abia după 72 ore (timp pentru întărire ulterioară la aerul din încăpere). Nu deteriorați suprafețele cu obiecte ascuțite și în niciun caz nu le expuneți radiației solare puternice.

ELIMINARE -Indicații privind eliminarea deșeurilor- De dragul mediului înconjurător, vă rugăm să eliminați deșeurile de ambalaj pe sortimente în tomberoanele de deșeur/reciclare prevăzute în acest scop și nu în natură. Piese de mobilier deteriorate sau inutilizabile pot fi predate la centre de reciclare speciale în scopul reciclării pieselor individuale. Piese de mobilier scoase din uz, dar încă funcționale nu trebuie eliminate imediat. Donați-le, de exemplu, la organizații caritabile.

Sperăm să vă bucurați de noul dumneavoastră mobilier.

1

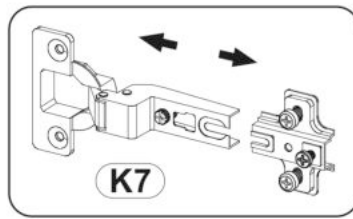
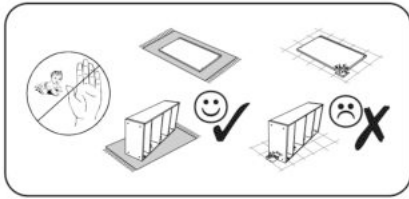

- B2**  x8
- 8x30** **x8**
- A1**  x4
- 15x12** **x4**
- K6**  x2
- ø35mm** **x2**
- K7**  x2
- ø35mm** **x2**

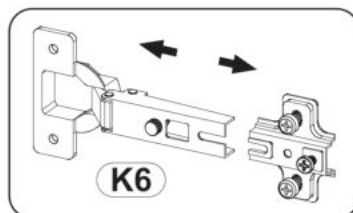
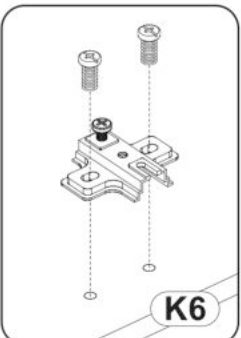
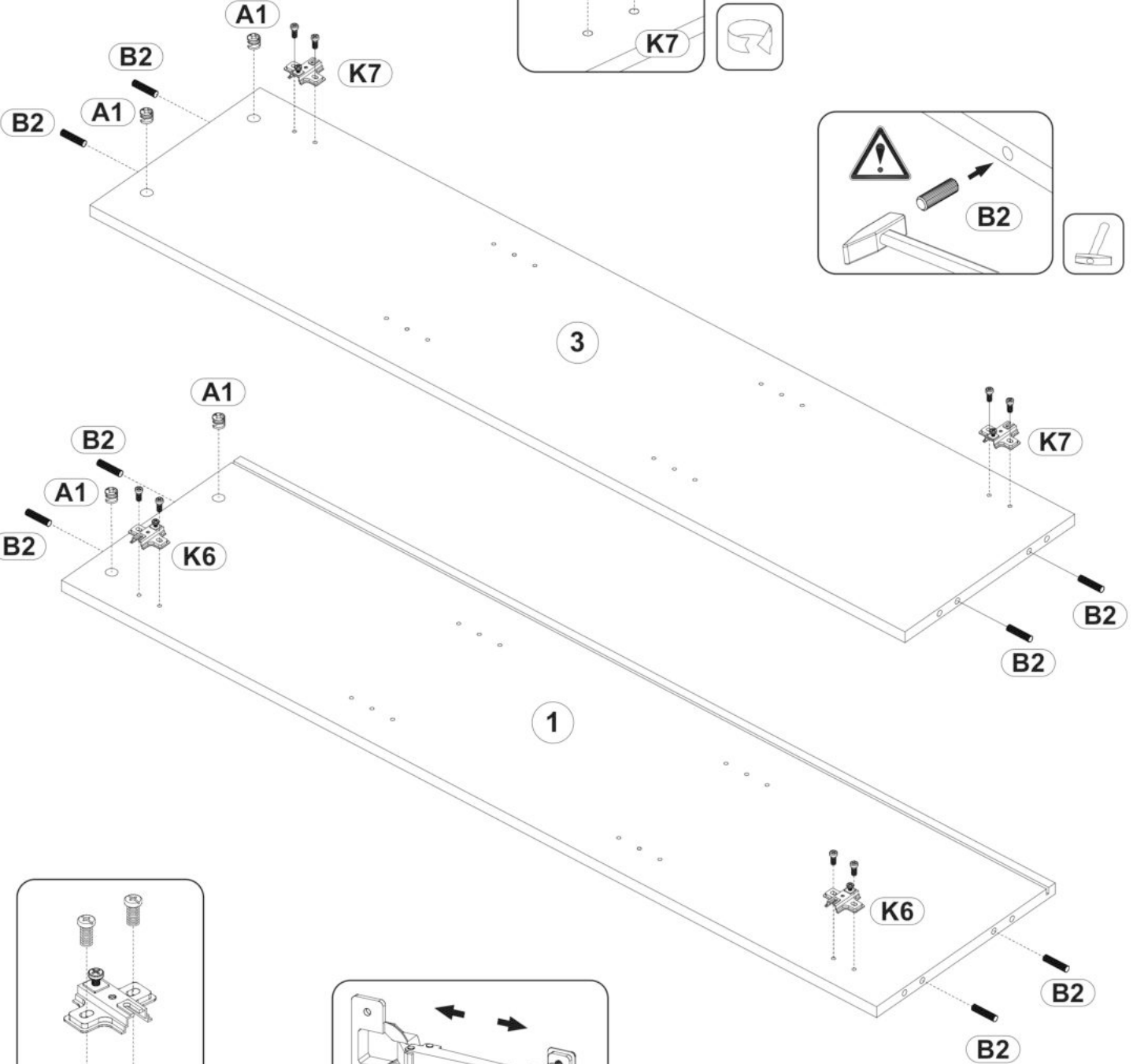
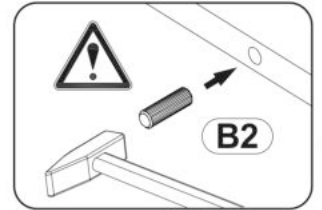
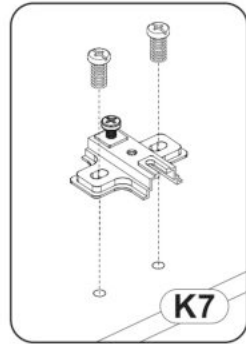

2

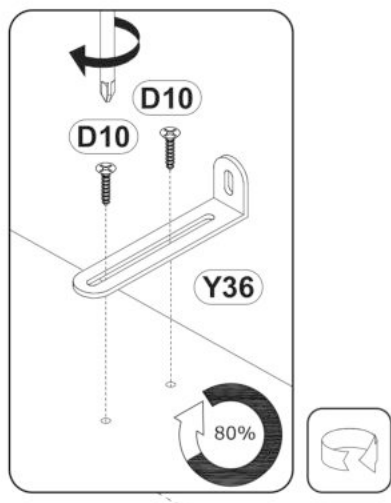
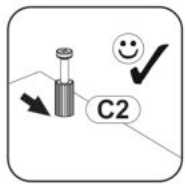
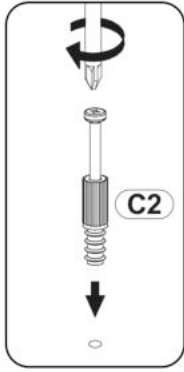
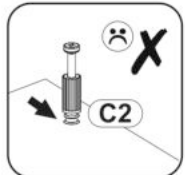
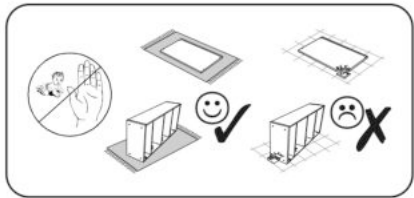

B2		x4
8x30		
A1		x2
15x12		
C2		x6
44mm		
Y36		x1
75x25x15		
D10		x2
3x16		
K6		x2
ø35mm		

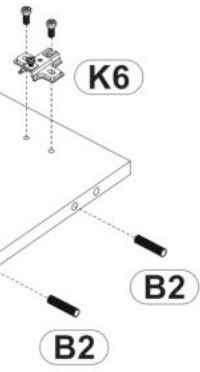
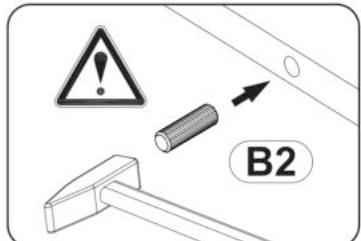
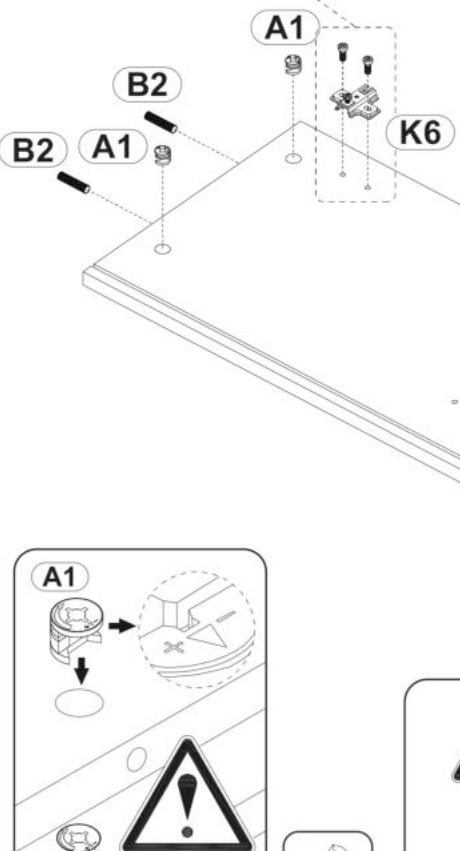
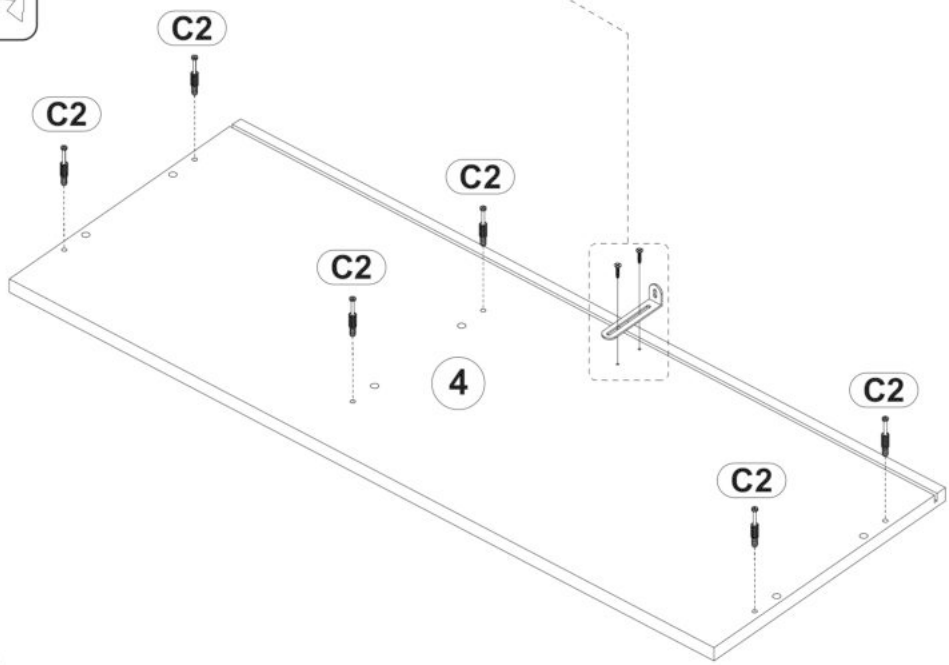
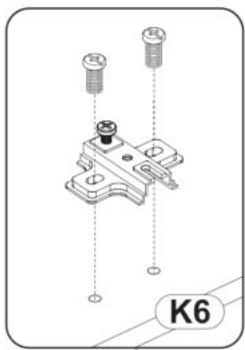

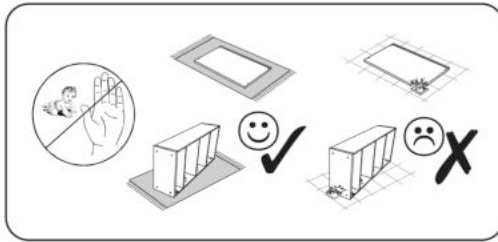

FA1		x1
4mm		
F3		x6
6,3x50		

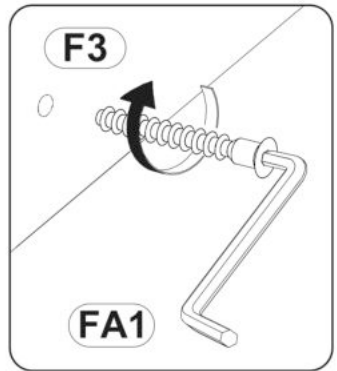
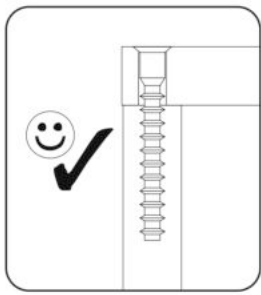
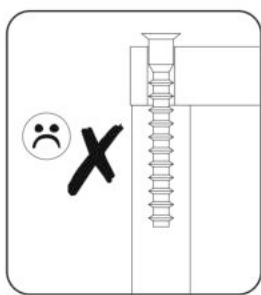
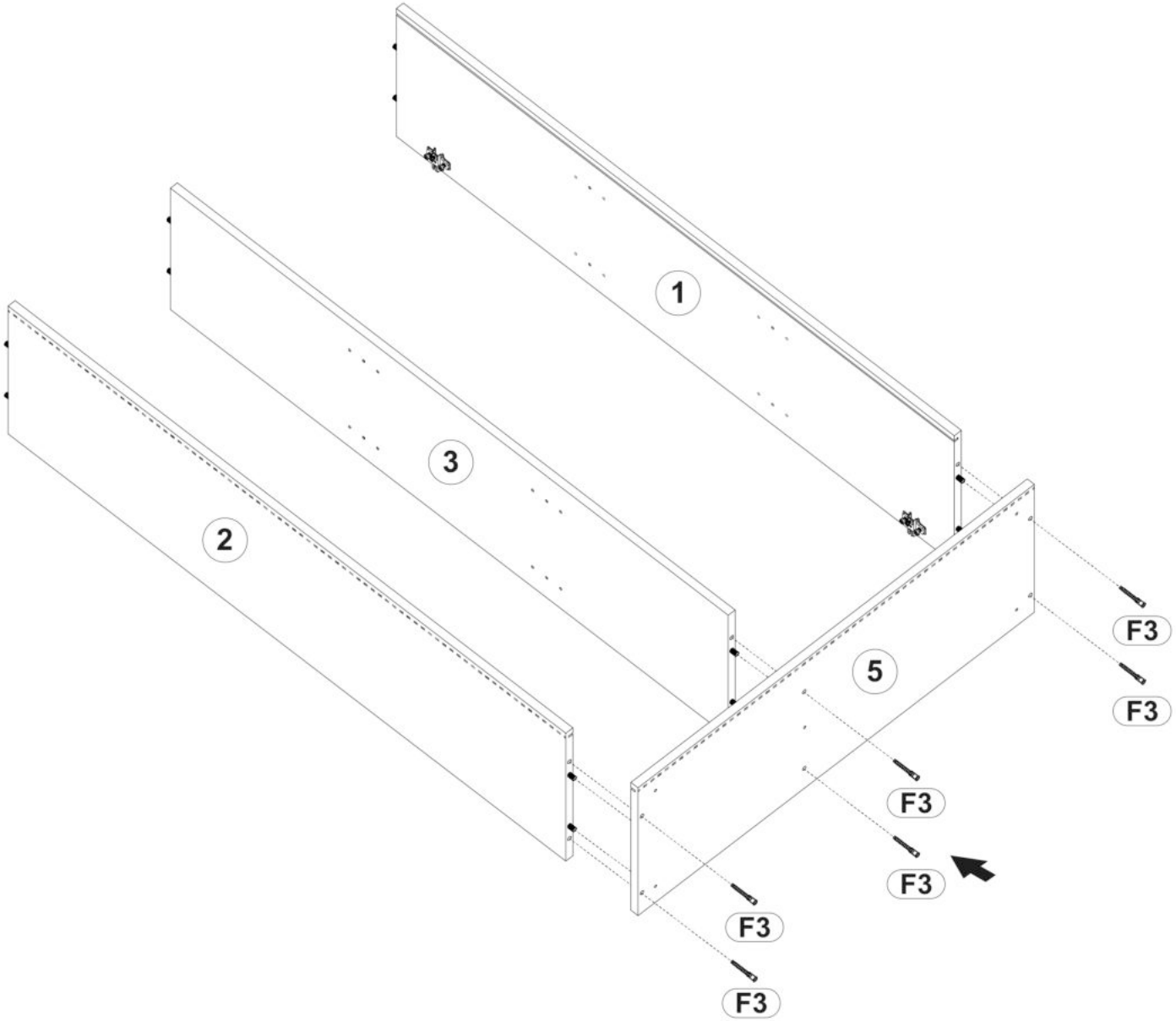

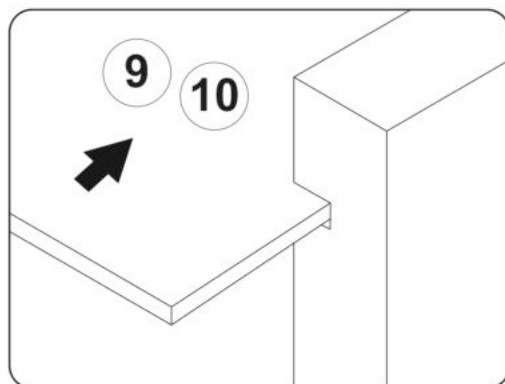
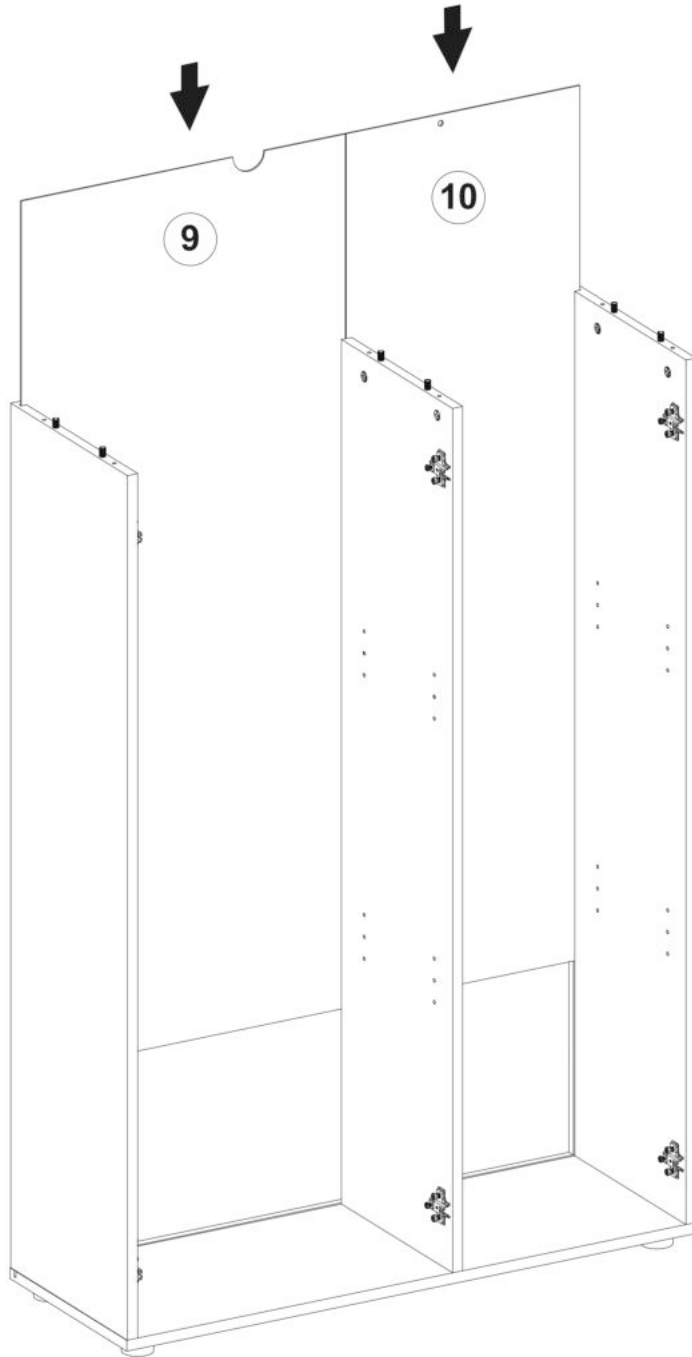

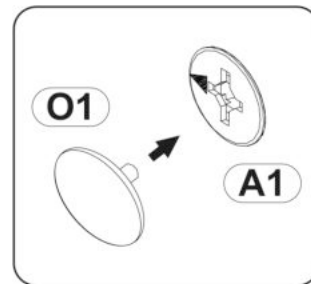
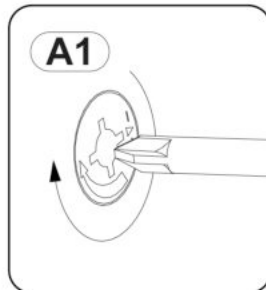
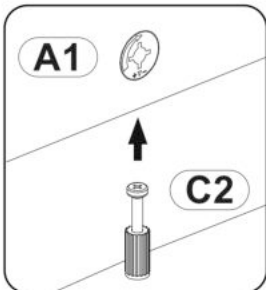
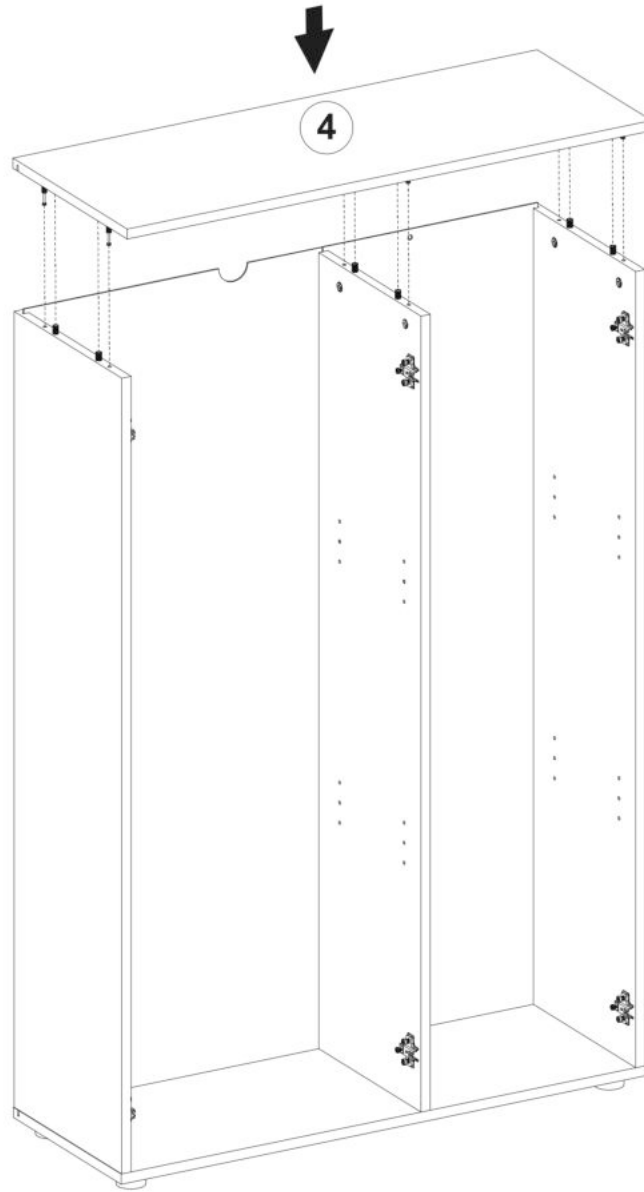

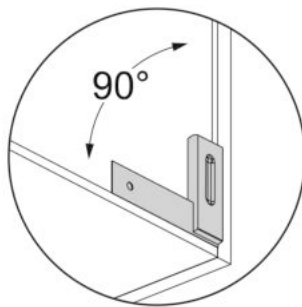
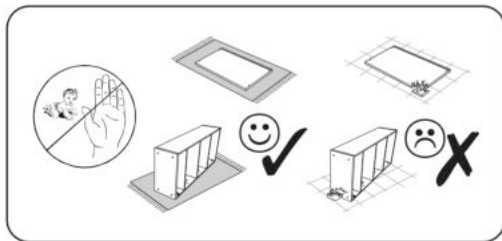

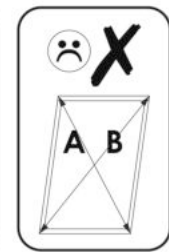
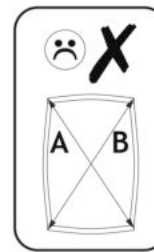
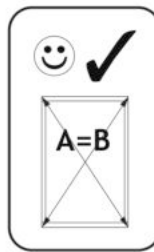
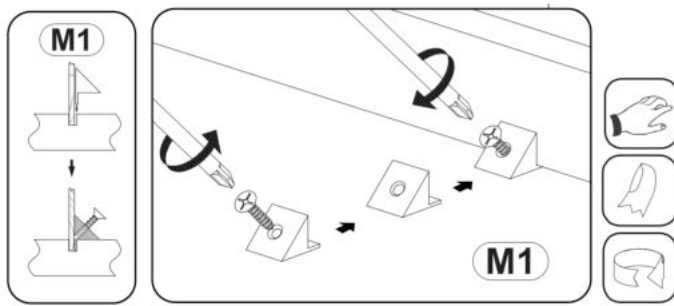
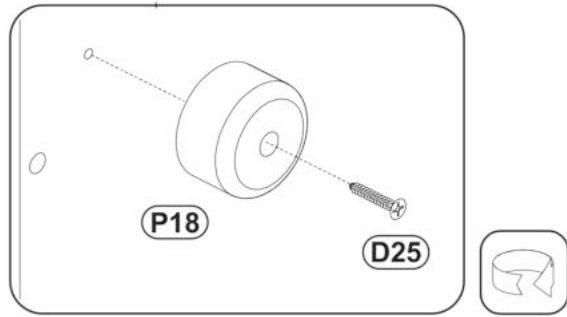
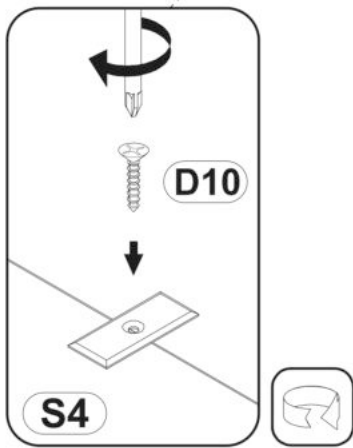
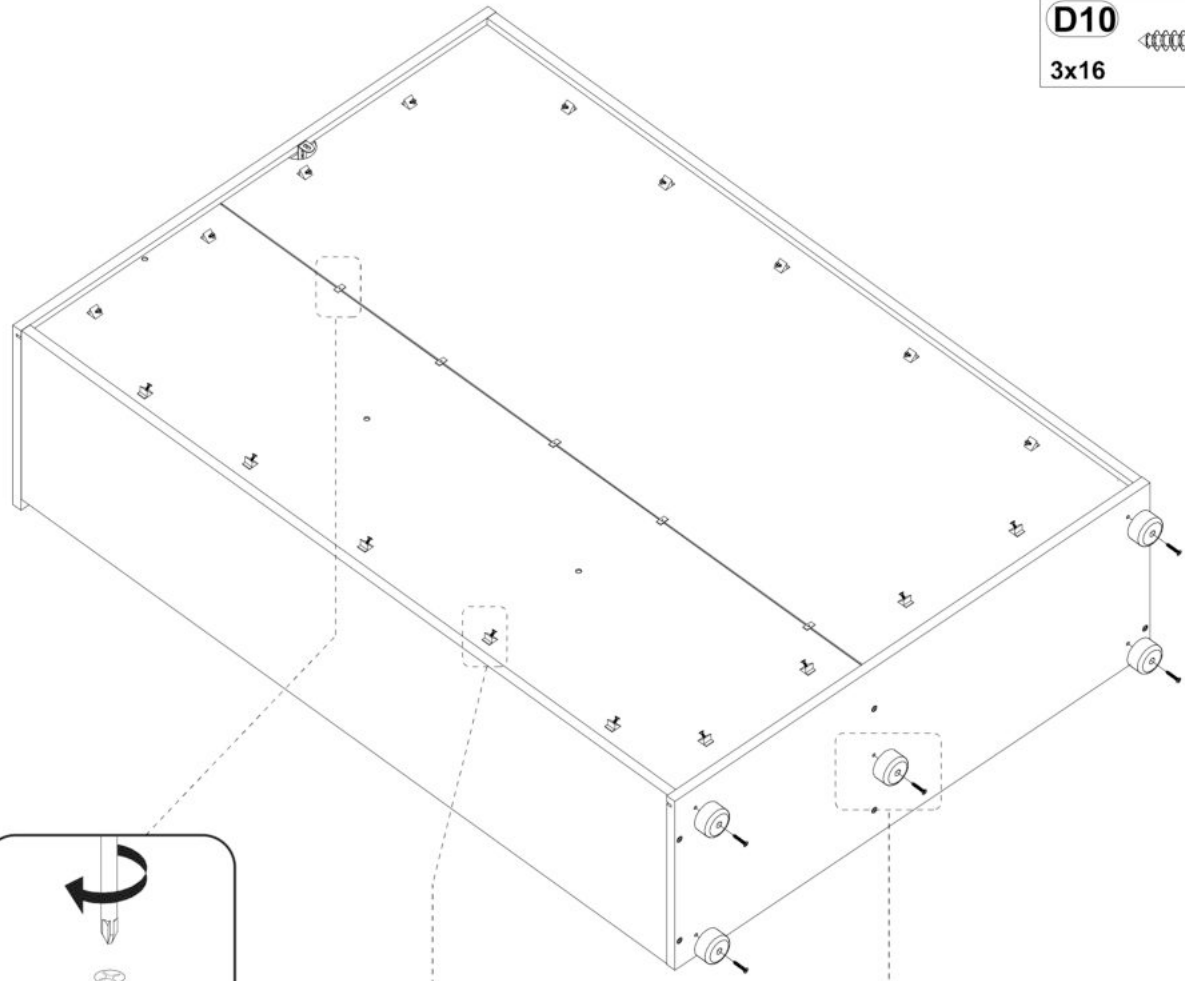

M1		x18
10x10x15		
P18		x5
45x25		
D25		x5
4x25		
S4		x5
20x10x2mm		
D10		x5
3x16		



Y35		
4,2x65		x1
Y37		
8x50		x1

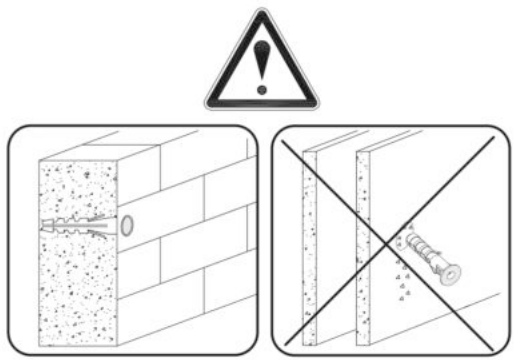
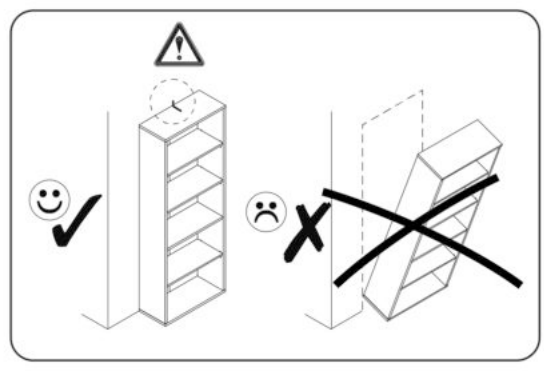
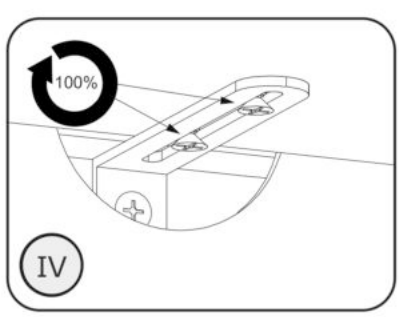
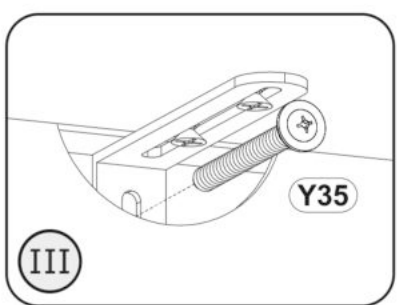
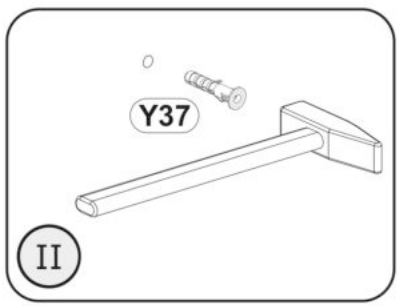
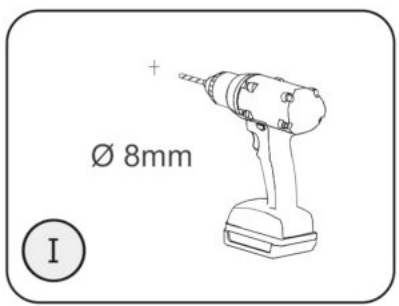

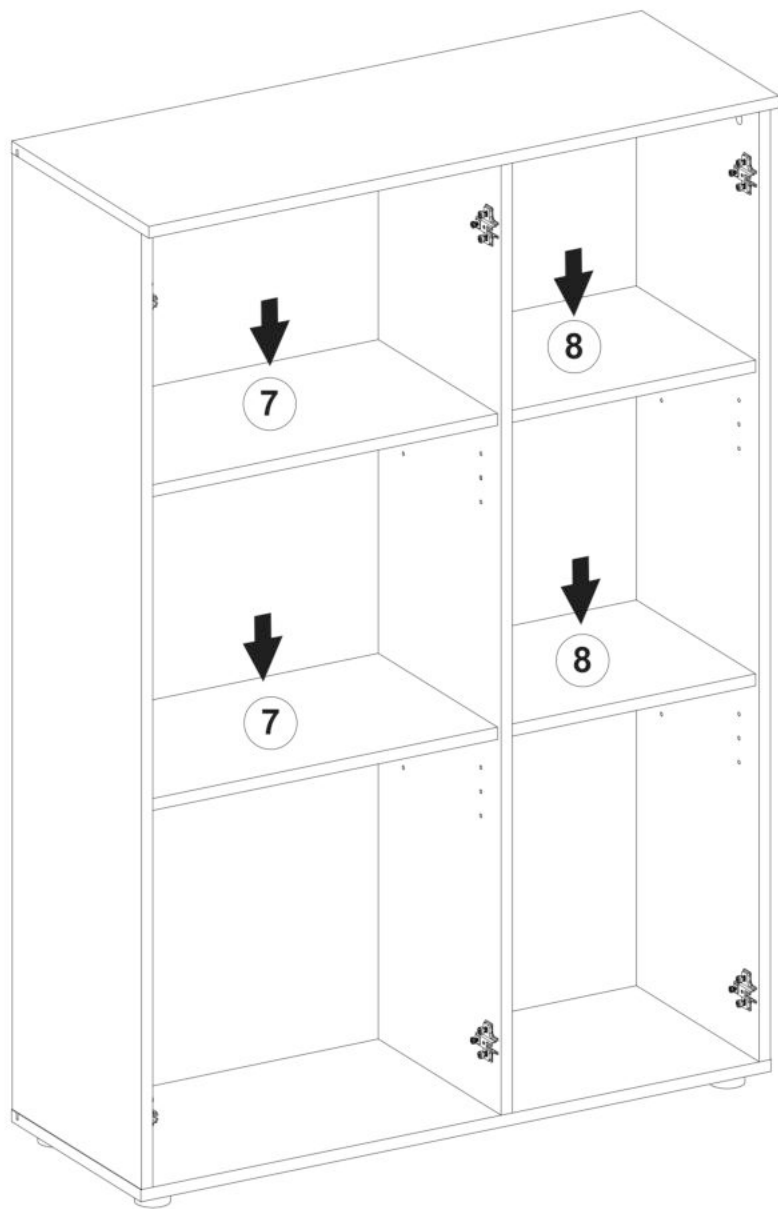



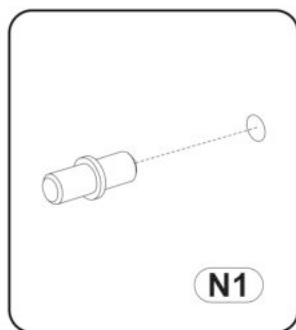

I

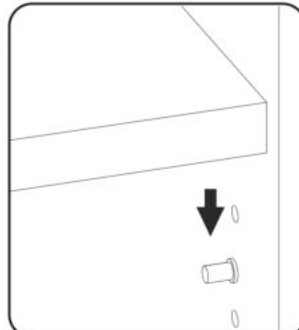

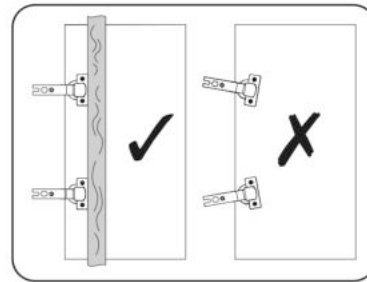
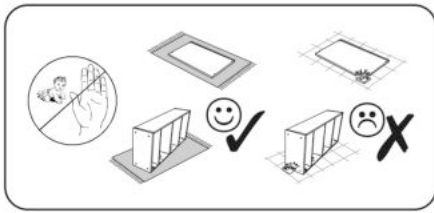
II

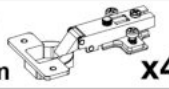

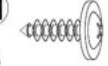



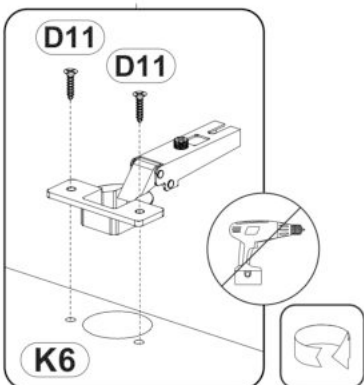
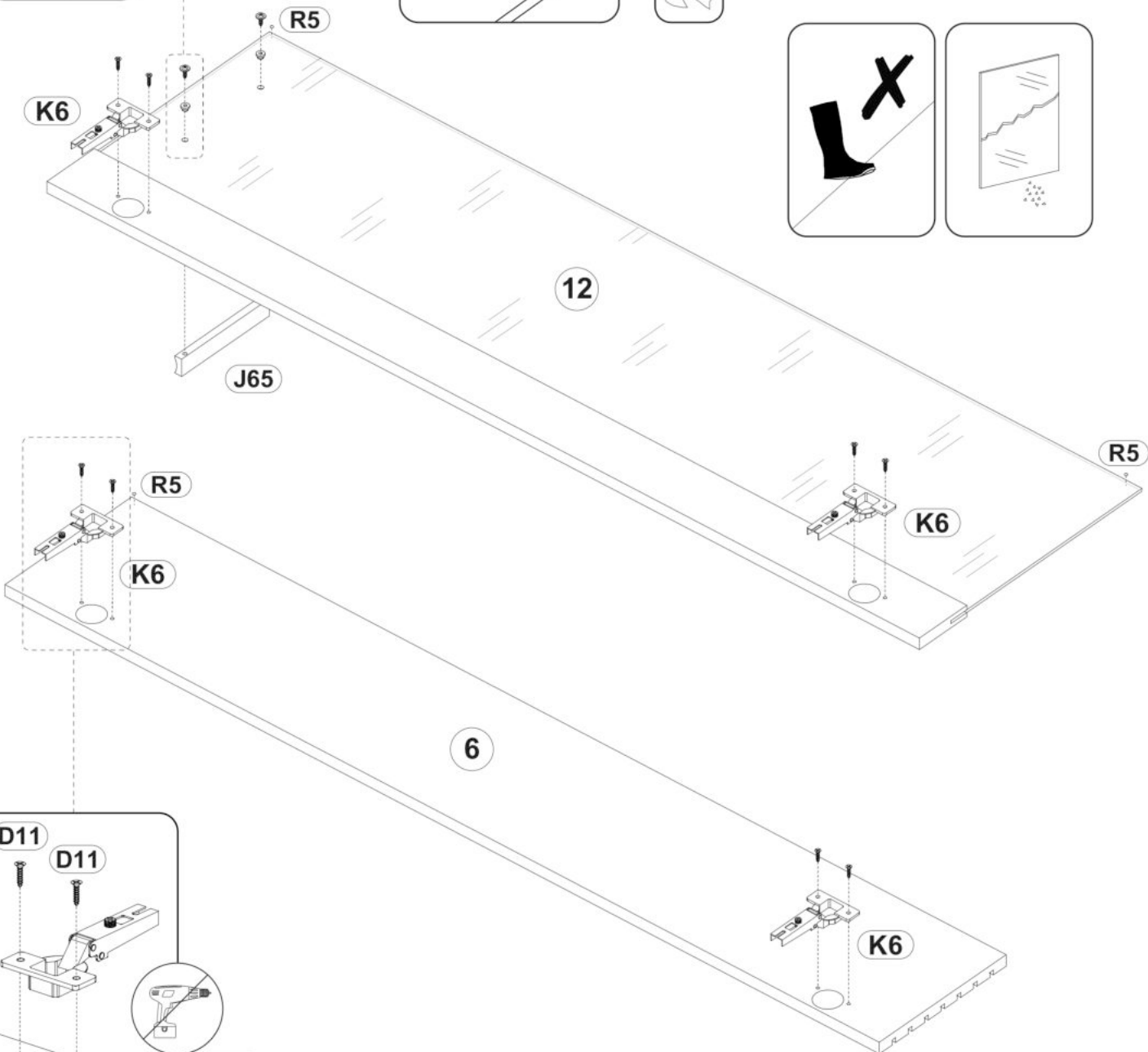
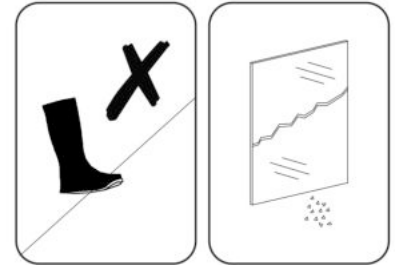
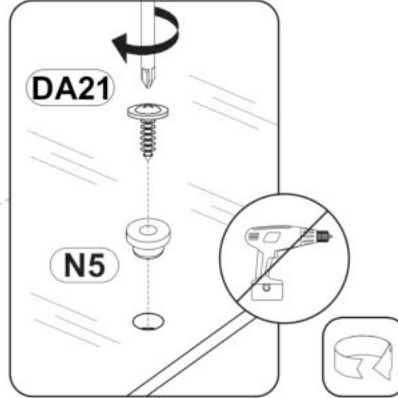
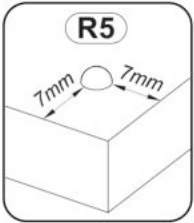

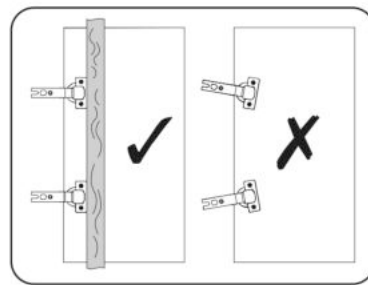
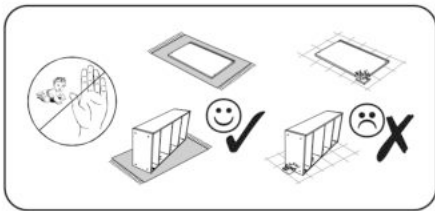
- K6**  **x4**
- ø35mm**
- D11**  **x8**
- 3,5x16**
- J65**  **x1**
- 128/148**
- DA21**  **x2**
- 4,2x16**
- R5**  **x3**
- ø6mm**
- N5**  **x2**
- 10x6x10**





- K7**  **x2**
ø35mm
- DB2**  **x2**
4x25
- D11**  **x4**
3,5x16
- J65**  **x1**
128/148
- R5**  **x1**
ø6mm

